



# TOWER PORTFOLIO



# THE PERFECT POUR

The Perfect Pouring Experience begins when a customer takes their first glance at the bar. The draught beer tower acts as a focal point and sets the stage for the patrons drinking experience. A high quality draught beer tower acts as a marketing tool to help drive profitable draught beer sales and induce customers to try out the products on tap. With so many different options and configurations let CBS help you select the right tower for your bar or restaurant to assist in the best guest experience!



# SEXY

This signature crafted draught tower, designed with elegant curves and a mirror polish finish, is truly Sexy.



Taps	1	2	3	4
Drip Trays	10"	10"	12"	15"
Cooling	Glycol, Air and Flooded/Ice			
Tap Style	American, European			
Options	Lit Medallions			

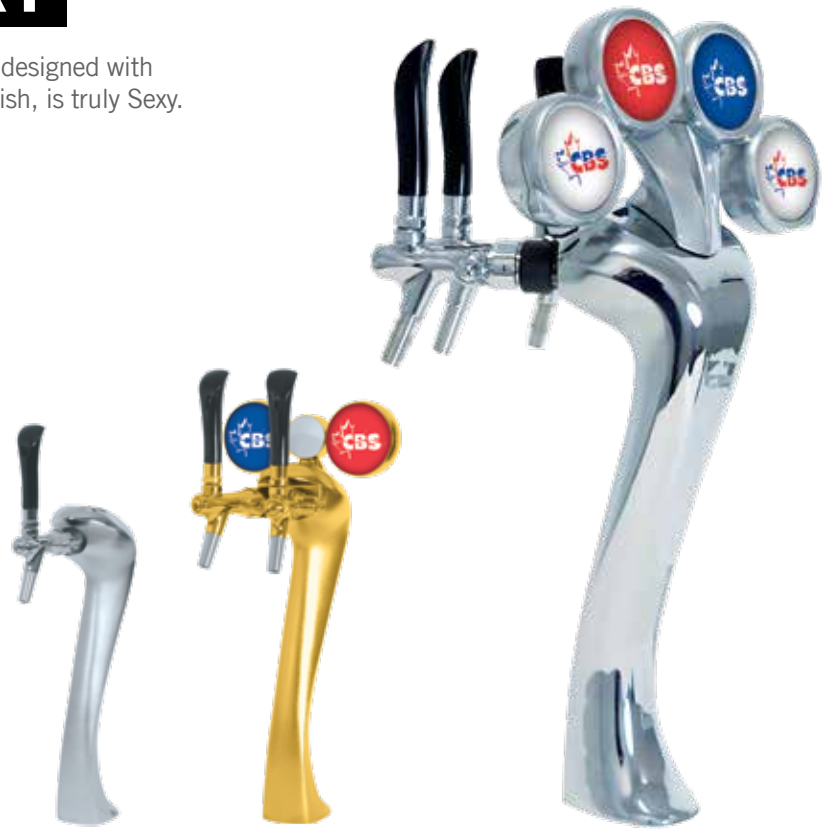

# LUCKY

This swirling draught tower adds a glamorous appeal to any bar or restaurant.



Taps	1	2	3
Drip Trays	10"	10"	12"
Cooling	Glycol, Air and Flooded/Ice		
Tap Style	American, European		
Options	Lit Medallions		



# SHIELD

The ultimate branding solution. These towers are equipped with customizable LED illuminated medallions which provides point of dispense graphics to show off the many brands you have available on tap!



Taps	1	2	3
Drip Trays	10"	10"	12"
Cooling	Glycol and Air		
Tap Style	American, European		
Options	Lit Medallions		



# MONGOOSE

The European produced Mongoose is a top selling tower that is available in 1, 2, 3, and 4 tap configurations; with or without branded medallions. The Mongoose's snake-like design is sure to grab the attention of anyone entering your establishment.



Taps	1	2	3	4
Drip Trays	10"	10"	12"	15"
Cooling	Glycol, Air and Flooded/Ice			
Tap Style	American, European			
Options	Lit Medallions			



# ZEUS



This classic, elegantly styled tower marries gold or chrome finish with a colored ceramic ring. Choose the color combination that fits best with your décor.



Taps	3	4	5
Drip Trays	210mm x 500mm cut-out		
Cooling	Glycol, Air and Flooded/Ice		
Tap Style	American, European		
Options	Lit Medallions		



# PANTHER



European quality and style, the Panther is a one piece classic shape that will attract attention to the brands it is dispensing.



Taps	3	4
Drip Trays	12"	15"
Cooling	Glycol, Air and Flooded/Ice	
Tap Style	American, European	
Options	Lit Medallions	



# MONACO

This premium tower provides exceptional performance and unique, eye-catching style to your space. This compact design is engineered to stand out in any setting.

MADE IN EUROPE



ASSEMBLED IN CANADA

MADE WITH



Taps	2/3	4/5	6/7
Drip Trays	20"	24"	36"
Cooling	Glycol, Air and Flooded/Ice		
Tap Style	American, European		



# IDEA

These simple but elegant towers capture the essence of modern design. They are perfect if you're looking for a small but elegant tower to dispense high quality product.

MADE IN EUROPE



ASSEMBLED IN CANADA

MADE WITH



Taps	1	2
Drip Trays	12"	15"
Cooling	Glycol and Air	
Tap Style	American, European	
Options	Lit Medallions	



# BRIGITTE

This tower is a great example of classic elegance combined with brand customization. The tower draws attention to the premium brands available on tap as well as the quality of the dispense system.



Taps	3	5	7
Drip Trays	20"	24"	36"
Cooling	Glycol and Air		
Tap Style	American, European		
Options	Lit Medallions		



# LANTERN

This tower is a unique and innovative way to efficiently dispense beer, wine, cider or all three through the wall! The design acts as a space saver and draws customers' attention to draught offerings for any bar or restaurant!



Taps	3	4	5
Drip Trays	12"	16"	16"
Cooling	Glycol and Air		
Tap Style	American, European		



Colors



# MUSHROOM

This versatile tower has a unique round shape that adds both style and function to your draught beer dispensing.

Taps	4	5	6
Drip Trays	14"	19"	24" Cutout
Cooling	Glycol and Air		
Tap Style	American, European		



# MINI MUSHROOM

This tower allows you to effortlessly and stylishly dispense your draught on tap. Add some character to your bar today!



Taps	3	4	5
Drip Trays	14" x 8" Cutout		
Cooling	Glycol and Air		
Tap Style	American, European		
Options	Lit Medallions		





# APOLLO

This sharp clean design is perfect for driving attention to specialty beverages.



Taps	1
Drip Trays	10"
Cooling	Glycol and Air
Tap Style	American, European
Options	Lit Medallions



# SUPER SEXY

These sharp, opulent european style towers are perfect if you're looking for a design that will catch the eye of any customer.



Taps	1	2
Drip Trays	10"	10"
Cooling	Glycol, Air and Flooded/Ice	
Tap Style	American, European	
Options	Lit Medallions	



# FAUCETS



*Fits Domestic Coupling Nut*



**303SS or 316SS Stout Faucet**



**303SS or 316SS Stout Faucet**



**PVD Brass 304SS Faucet**



**Gold Plated Brass Faucet**



**Black, White or Burgundy Plastic Faucet**



**Chrome Plated Brass Faucet**



**304SS Faucet**



**Polished Brass Faucet**



**304SS Perlick 630SS Faucet**



**304SS Perlick 650SS Flow Control Faucet**



*Fits European Coupling Nut*



**304SS Quix Flow Control Faucet with Shank**



**316SS Flux Flow Control Faucet with Shank**



**Chrome Plated Brass Flow Control Faucet with Shank**

# DRIP TRAYS

**NO DRAIN**



**5-3/8" Wide**

**WITH GLASS RINSER**



**7" or 8" Wide**

**WITH DRAIN**



**5-3/8" or 7-11" Wide**

**PLATFORM**



**15-3/4" or 19-11/16" Wide**

# CUSTOM DESIGN

## DREAM

## You Dream it, We'll Build it!

Our experienced team of talented craftsmen are ready to work with you through our 4D process to make the vision of how you want your tower to look into a reality.

We'll take your vision for your tower and drip tray from Dream to Delivery. Our custom solutions department will work side by side with you throughout the Design & Develop stages to ultimately Deliver a uniquely crafted tower that exceeds your expectations. Our reputation for creating custom dispensing solutions is well established and we keep you - our customer, at the heart of everything we do. We will deliver your vision on time and within budget.

## DESIGN

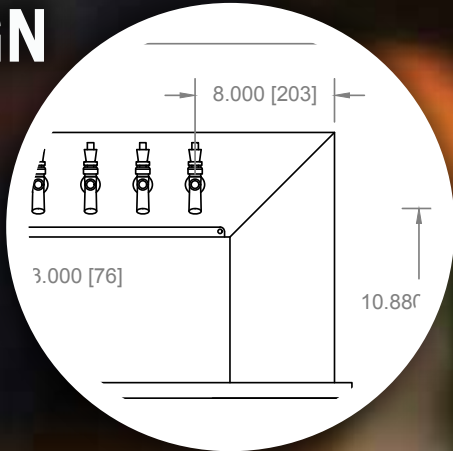

## DEVELOP

## DELIVER



# CUSTOM TOWERS

High quality towers are meant to show off your brand and product offering the way you envision it. Custom towers are a great option for themed restaurants and bars and there really are no limits when it comes to tower design options.

Creativity + Quality = the optimal customer experience.

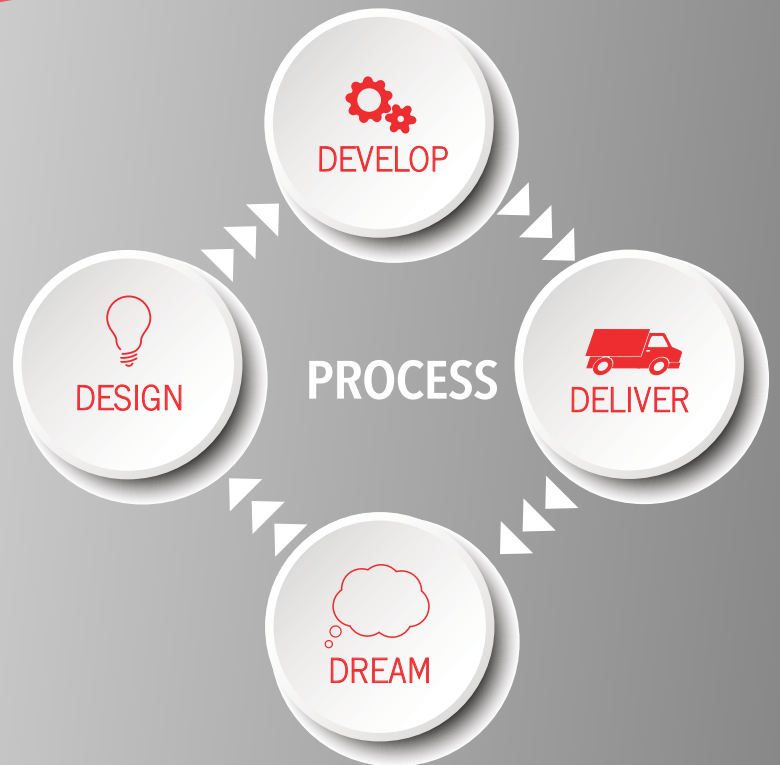



# Materials & Finishes

- Cast Iron
- Stainless Steel
- Aluminum
- Brushed
- Polished
- Powder Coat
- PVD
- Clear Coat

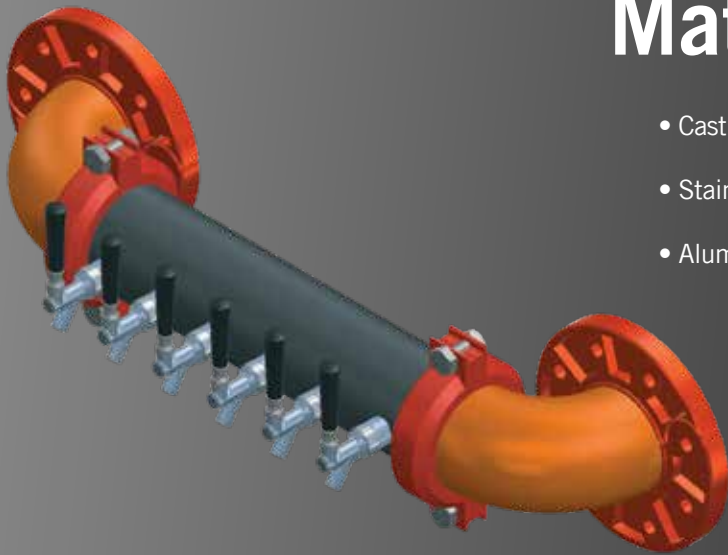

# METRO SERIES



## METRO "H"

Taps	8	10	12	14	16
Drip Trays	28"	34"	40"	46"	52"
Cooling	Glycol and Air				
Tap Style	American				

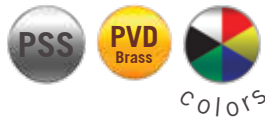

## METRO "T"

Taps	4	6	8	10	12
Drip Trays	20"	24"	30"	36"	36"
Cooling	Glycol and Air				
Tap Style	American				
Options	Medallions				

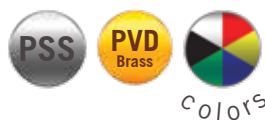



## METRO "HHH"

Taps	24	30	36
Drip Trays	3 x 28"	3 x 34"	3 x 40"
Cooling	Glycol and Air		
Tap Style	American		
Options	Medallions		



## METRO "M"

Taps	16	20	24
Drip Trays	3 x 28"	3 x 34"	3 x 40"
Cooling	Glycol and Air		
Tap Style	American		

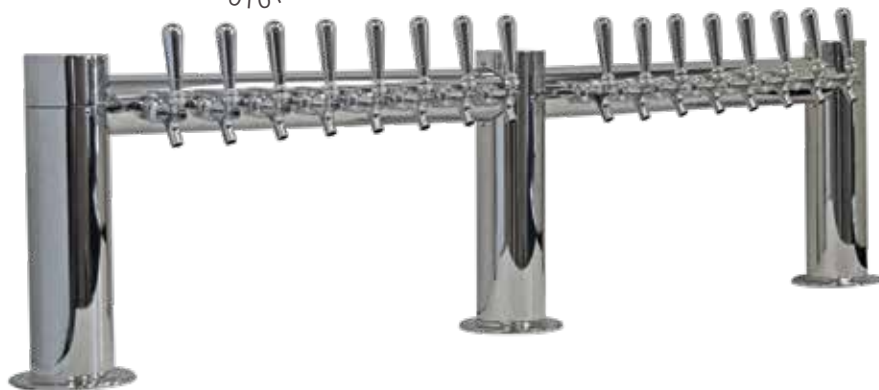

# PASS THRU

The Pass Thru has become a top selling tower for bars looking to dispense 6+ products.

Our Pass Thru tower is designed and manufactured to stand up to the rigors of any busy bar.



Taps	6	8	10	12	14	16
Drip Trays	20"	24"	30"	36"	45"	51"
Cooling	Glycol and Air					
Tap Style	American, European					
Options	Lit Medallions					



# DOUBLE PEDESTAL

These heavy duty commercial draught beer towers are high quality and long lasting. Dispense beer as it was intended to taste!



Taps	8	10	12	14	16	20	
Drip Trays	24"	30"	34"	45"	51"	2 x 30"	2 x 36"
Cooling	Glycol and Air						
Tap Style	American, European						







# 4" T-TOWER

These towers are a classic go-to for a large variety of beer offered on tap. They are constructed from premium quality stainless steel and engineered to stand the test of time.

Taps	4	5	6	8
Drip Trays	12"	15"	20"	24"
Cooling	Glycol and Air			
Tap Style	American, European			



# 3" T-TOWER

Taps	3	4	5	6
Drip Trays	12"	12"	15"	20"
Cooling	Glycol and Air			
Tap Style	American, European			



# MODULAR SS TUBE TOWERS

This line of towers offers the ultimate flexibility with a small footprint. The Modular line can be connected and customized to fit any dispensing need. Suspend from the ceiling, mount on the wall, anything your imagination can come up with, the Modular line can handle. Built with commercial grade stainless steel, polished to a brilliant shine, these towers are built to last and look great!



## CONDOR

Taps	4	6	8	10
Drip Trays	30"	33"	45"	51"
Cooling	Glycol and Air			
Tap Style	American, European			
Options	Lit Medallions			



## LINX R7 & L7

Taps	2	3	4	5	6
Drip Trays	12"	12"	16"	20"	24"
Cooling	Glycol and Air				
Tap Style	American, European				
Options	Lit Medallions				



## LIONS GATE

Taps	6	8	10	12	14
Drip Trays	30"	36"	45"	51"	30" x 2
Cooling	Glycol and Air				
Tap Style	American, European				
Options	Lit Medallions				



# BRIDGE

Taps	6	8	10	12
Drip Trays	20"	24"	30"	36"
Cooling	Glycol and Air			
Tap Style	American			



# RAIL

Taps	6	8	10	12
Drip Trays	20"	24"	30"	36"
Cooling	Glycol and Air			
Tap Style	American			



# ALBATROSS

Taps	4	6	8	10
Drip Trays	2 x 12"	2 x 16"	2 x 20"	
Cooling	Glycol and Air			
Tap Style	American			
Options	Lit Medallions			



# LIONS GATE 3P

Taps	12	16	20	24
Drip Trays	2 x 24"	2 x 36"	4 x 20"	2 x 51"
Cooling	Glycol and Air			
Tap Style	American			
Options	Lit Medallions			



# KRONOS

These towers are modern, state-of-the-art beverage dispensing solutions. The shine of the stainless steel catches the eye and the simple design draws attention to the beverage being served.



Taps	6	8	10	12
Drip Trays	18"	24"	30"	36"
Cooling	Glycol and Air			
Tap Style	American, European			



# KRONOS(GR)

Like the standard Kronos tower above, this tower is designed to display a clean appearance so the customer can focus on the beverage being dispensed. This is a complete tower, equipped with a high quality drip tray with a glass rinser so the beverage can taste as intended.



Taps	6	8	10	12
Drip Trays	18"	24"	30"	36"
Cooling	Glycol and Air			
Tap Style	American, European			



# UNDERBAR CABINET

The premium version of a standard underbar cabinet, this tower is crafted to be long lasting and durable. All parts are integrated into one high-performing system. Easily remove the front panel for access to the system components.



Taps	4	5	6	8	10	12
Drip Trays	20"	24"	30"	40"	40"	40"
Cooling	Glycol and Air					
Tap Style	American, European					



# SPACE MIZER

This dispenser is designed to minimize the space taken up for the beverage dispensing unit while maximizing the quality of the product being dispensed.



Taps	3	4	5	6	8	12	14
Drip Trays	15"	15"	20"	20"	24"	30"	36"
Cooling	Glycol and Air						
Tap Style	American, European						





# COLUMN

These are high quality, compact units that fit in just about any setting. Add a medallion to display your brand at the point of dispense.



Taps	1	2	3	4
Drip Trays	10"	10"	10"	14" Cut Out
Cooling	Glycol and Air			
Tap Style	American			
Options	Lit Medallions			



# LEGEND



**Chrome Plated**



**Brushed Stainless Steel**



**PVD Brass**



**Polished Stainless Steel**



**Gold Plated**



**Dark Nickel**



**Custom Colors**

Colors



**Ice**



**CHILL-MAX™  
Cooling Cartridge**

# BRAND YOUR WAY

Want to stand out from the rest? Our in-house print capabilities can help you stand out from the pack! Let CBS add your brand, design and logo to almost any tower!





10 - 3350 RIDGEWAY DRIVE  
MISSISSAUGA, ON, CANADA  
L5L 5Z9  
PHONE: 905-569-7707  
TOLL FREE: 1-888-303-7707  
FAX: 905-569-6585  
E-MAIL: sales@cdnbev.com

108A - 17533 64TH AVE.  
SURREY, BC, CANADA  
V3S 1Y8  
PHONE: 604-575-4771  
TOLL FREE: 1-866-360-2205  
FAX: 604-575-4772  
E-MAIL: sales@cdnbev.com

600 MAIN ST.  
TONAWANDA, NY, USA  
14150  
PHONE: 905-569-7707  
TOLL FREE: 1-888-303-7707  
FAX: 905-569-6585  
E-MAIL: sales@cdnbev.com

1124 FIR AVENUE  
BLAINE WA  
98230  
PHONE: 604-575-4771  
TOLL FREE: 1-866-360-2205  
FAX: 604-575-4772  
E-MAIL: sales@cdnbev.com

